

## RAMO 22 S, M12, round collar, 2 NO, Gold, M12 8-pin A-coded, frontring black, 2 x 60°, latching



### fields of application

- > Measurement-control-regulation
- > Electrical engineering
- > Mechanical and system engineering
- > Signalling systems
- > Vehicle construction
- > Chemical industry
- > Industrial robots

### special features

- > Precise haptics
- > Safe gold contacts
- > Simple M12 plug&play connection
- > Protected contacts due to sealed housing



## description

The RAMO S selector switches offer a solution for every application thanks to a wide variety of contact functions, rotation angles, actuation functions and illuminated panels.

Just like all RAMO actuators, connection is simple using Plug&Play and without any manual wiring - with M12 sensor cables.

Additional information according to UL certificate:

For Class 2 Power Source or Limited Voltage / Limited Current only

Installation only by trained specialist personnel.

Type 4x Indoor only with cable "Cat. No. 7000-08061-0210100 PUR 4x0.25mm<sup>2</sup> with M8 connector, rated max. 30VAC/DC 4A, manufactured by Murrelektronik GmbH" and "Cat. No. 7000-12221-0340100 PUR 4x0.34mm<sup>2</sup> with M12 connector, rated max. 30VAC/DC 4A, manufactured by Murrelektronik GmbH"

For Use on a Flat Surface of a Type 1 or 4x indoor only Enclosure.

## technical data

### > general

Potential free	no
Color	black
Bezel color	white
Property of bezel / mushroom	transparent
Collar color	black
Front ring color	black
Luminous element color	white
Collar shape	round
Operating temperature, min.	-40 °C
Operating temperature, max.	85 °C

### direct links

- > RAFI eCatalog

Storage temperature, min.	-40 °C
Storage temperature, max.	90 °C
illuminated	Yes
Luminous elements	LED
Packaging	Box
Packaging unit	2 pcs.
net weight	16.9 g
Operating life	200,000 cycles
B10	250,000 cycles
Degree of protection, front side, according to DIN EN 60529	IP65
Degree of protection, rear side, according to DIN EN 60529	IP65
UL Enclosure Type Rating front side	type 4X indoor
Environment resistance	IEC 60068-2-14 IEC 60068-2-30 IEC 60068-2-78
Shock resistance according to standard IEC 60068-2-27	30 g at 11 ms amplitude semi-sinusoidal
Salt-spray resistance according to standard	IEC 60068-2-11
shock resistance	02 side 08 frontal
oscillation resistance according to standard IEC 60068-2-6	5 g at 10...500 Hz
MOQ order	2 pcs.
Pollution degree acc. to DIN EN 61010-1	Pollution degree 2
RoHS compliant	Yes
REACH compliant	Yes
<b>&gt; mounting diameters</b>	
Outside dimension, length	29.8 mm
Outside dimension, width	29.8 mm
Outside dimension, height	53.9 mm
Mounting hole	22.3 mm
Mounting depth	30.1 mm
Installation height	23.8 mm
Grid, min.	30 mm
<b>&gt; mechanical data</b>	
Actuation function	latching
Resistance to force on the side	300 N
Contact function	2 NO
Contact material	Gold
Rotating angle	2 x 60°
Fixing	Threaded ring
Threaded ring torque, max.	1.2 Nm
Terminal on the rear	M12 8-pin A-coded

PIN 1	Normally open contact 1 Normally open contact 2
PIN 2	Normally open contact 2
PIN 3	GND
PIN 4	Normally open contact 1
PIN 5	LED +

> **electrical data**

Rated insulation voltage	250 V
Rated surge voltage	2,500 V
Rated operating voltage	35 V (AC-15) 35 V (DC-13)
Operating voltage of the luminous element, min.	22 V
Operating voltage of the luminous element, max.	26 V
Rated voltage, min.	1 V
Rated voltage, max.	32 V
Voltage type	DC
Rated operating voltage	1-32 V
Operating current of the luminous element, max.	25 mA
Rated current, max.	0.1 A
Power loss	0.70080 W
Overvoltage category	2
Kind of short circuit protective device	fuse 250 V / 0,1 A / 1,5 kA gG quick
Conditional short circuit current	1,000 A

**drawings**

**Dimensioned drawing**

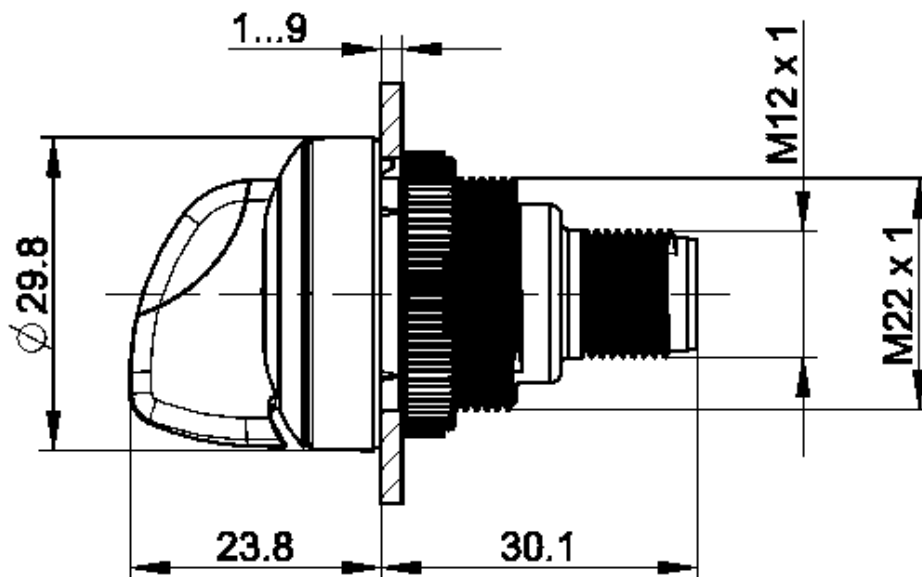

**Mounting hole drawing**



acc. to IEC 60947-5-1

**Schematic diagram**

