

## LUMOTAST 75 IP40, illuminated pushbutton, square collar, flat bezel, momentary contact function, 2 NC + 2 NO



### fields of application

- › Measurement-control-regulation
- › Mechanical and system engineering
- › Signalling systems

### special features

- › Mounting hole diameter 16.2 mm
- › 3 collar shapes – also rectangular
- › 20 different actuating and indicator elements
- › Keylock switch with 2 switching positions in compatible design – round and rectangular
- › Lamp socket: T4.5: full-surface illumination with LED is possible
- › Silver contacts with self-cleaning snap-action contact bridge for safe switching, suitable for large currents (max. 250 V / 4 A)
- › Water splash protection class IP 40 on front
- › available contact configurations: 1 NC + 1 NO or 2 NC + 2 NO
- › Solder terminal



### description

LUMOTAST 75 illuminated pushbuttons and signal lamps have been in use for decades. They are the most successful mono-switches in RAFI history. The wide range of collar shapes in classic design and the established terminal and legending concept make the LUMOTAST 75 series one of your most reliable components. Keylock switches compatible with the design are also available. The basic LUMOTAST 75 model complies with IP 40 protection class according to DIN.

Lens covers and diffusing discs must be ordered separately.

### technical data

#### › general

Collar color	black
Collar shape	square
Operating temperature, min.	-25 °C
Operating temperature, max.	55 °C
Storage temperature, min.	-40 °C
Storage temperature, max.	80 °C
illuminated	Yes
Lamp socket	T4.5
Packaging	Box
Packaging unit	10 pcs.

#### direct links

- › [RAFI eCatalog](#)

net weight	13 g
Operating life electrical	200,000 (2A / 250V AC) cycles 60.000 (4A / 250V AC) cycles
B10	260,000 cycles
Degree of protection, front side, according to DIN EN 60529	IP40
Protection class	II
MOQ order	20 pcs.
RoHS compliant	Yes
REACH compliant	Yes
<b>&gt; mounting diameters</b>	
Outside dimension, length	18 mm
Outside dimension, width	18 mm
Outside dimension, height	57 mm
Mounting hole	16.2 mm
Mounting depth	49.5 mm
Installation height	7.5 mm
<b>&gt; mechanical data</b>	
Actuation function	momentary contact function
Operating force, max.	6.5 N
Operating force, min.	3 N
Operating travel, max.	2.7 mm
Contact function	2 NC + 2 NO
Contact system	Bridge-snap-action contact
Contact material	Silver
Fixing	Threaded ring
Solderability	Yes
Terminal on the rear	Solder terminal
<b>&gt; electrical data</b>	
Rated voltage, min.	12 V
Rated voltage, max.	230 V
Rated current, min.	0.05 A
Rated current, max.	4 A

**drawings**

**Dimensioned drawing**

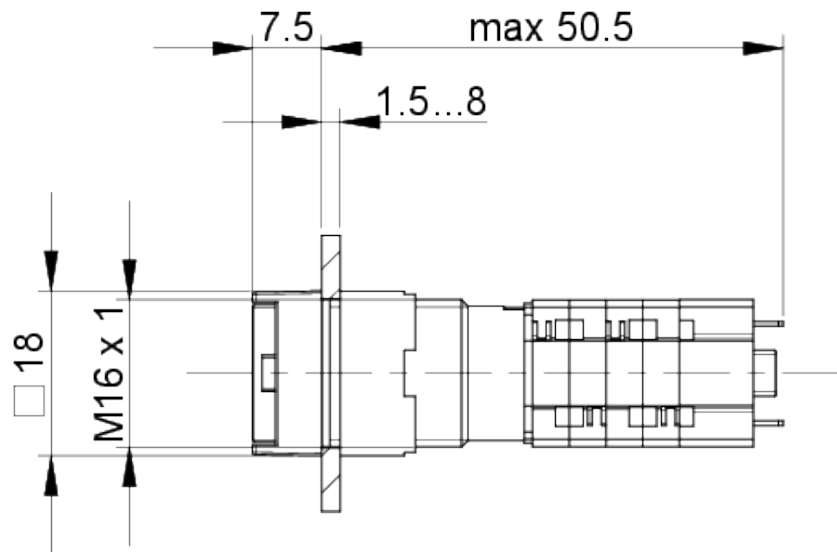

**Mounting hole drawing**

