

RAFIX 16 F, keylock switch, round collar, 2 x 40°, momentary contact function



fields of application

- › Measurement-control-regulation
- › Electrical engineering
- › Mechanical and system engineering
- › Vehicle construction

special features

- › Robust - also suitable for operation with gloves
- › Close mounting of actuators possible, as wiring is axial from the rear
- › Degree of protection: IP 65 at the front
- › Separate switching elements UNIVERSAL required
- › Switching elements with silver contacts (max. 250 V / 6 A) or gold contacts (max. 35 V / 0.25 A)
- › Connection types: screw connection, plug-in connection, PCB plug-in socket
- › The switching elements are snapped on and can be removed again by turning.



description

The locking systems we use were created according to the DIN EN 1303 standard by well-known lock manufacturers. They are open, mechanical systems which, depending on the environmental conditions, require occasional maintenance (e.g. greasing & oiling) by the machine or system operator.

RAFIX control units are modular units consisting of several parts. In the RAFIX 16 product family, these always consist of an actuating element and a switching element. Actuating elements (such as key switches) have the specified tactility, reset and function only when assembled with the appropriate switching elements.

With RAFIX 16 actuating elements, you can choose between three collar shapes: round, square or square side-by-side, in which the pushbuttons can be lined up seamlessly. The mounting diameter is 16.2 mm according to the standard. The anti-rotation lug can be easily removed with a screwdriver if necessary.

technical data

› general

Scope of delivery	2 keys
Bezel color	black
Property of bezel / mushroom	opaque
Collar color	metallic silver

direct links

- › [RAFI eCatalog](#)

Collar shape	round
Operating temperature, min.	-25 °C
Operating temperature, max.	70 °C
Storage temperature, min.	-40 °C
Storage temperature, max.	85 °C
illuminated	No
Packaging	Box
Packaging unit	10 pcs.
net weight	30.7 g
Operating life	65,000 cycles
B10	84,500 cycles
Degree of protection, front side, according to DIN EN 60529	IP65
Environment resistance	IEC 60068-2-14 IEC 60068-2-30 IEC 60068-2-33 IEC 60068-2-78
MOQ order	10 pcs.
RoHS compliant	Yes
REACH compliant	Yes
> mounting diameters	
Outside dimension, length	28 mm
Outside dimension, width	28 mm
Outside dimension, height	48.4 mm
Mounting hole	22.3 mm
Mounting depth	50 mm
Installation height	24.1 mm
Grid, min.	30 x 30 mm
Collar dimension	ø 28 mm
> mechanical data	
Actuation function	momentary contact function
Operating torque, max.	1.3 Nm
Locking position	1
Key lock	Micromec
Rotating angle	2 x 40°
Fixing	Threaded ring
Threaded ring torque, max.	1.2 Nm

drawings

Dimensioned drawing

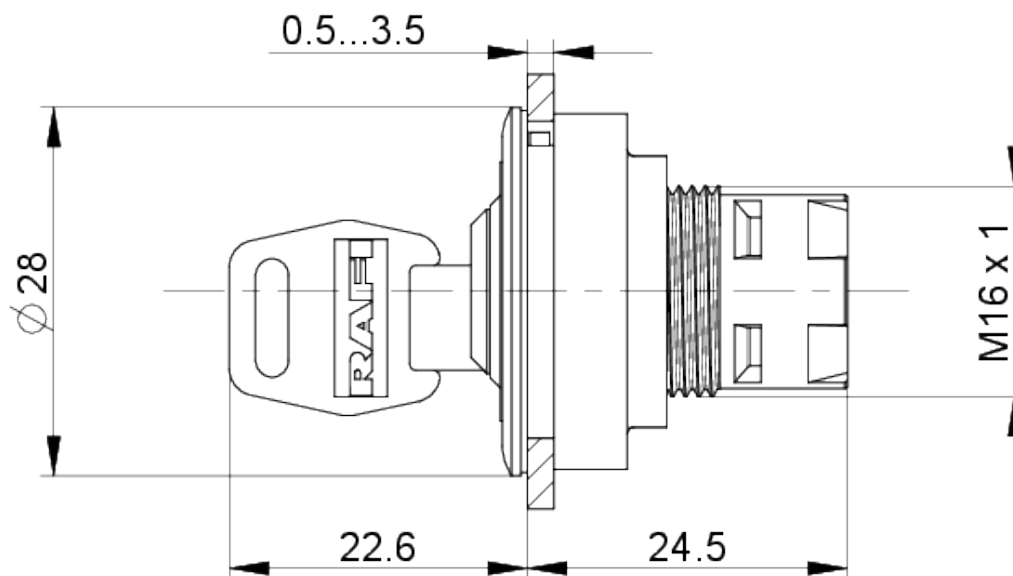

Mounting hole drawing

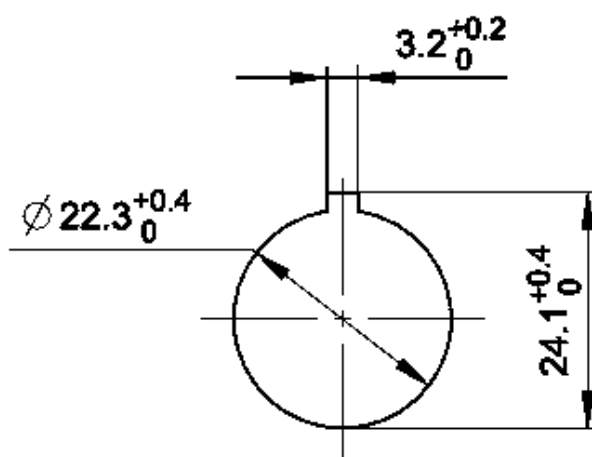

acc. to IEC 60947-5-1