

## Signal lamp with integrated LED, 5 mm, flat round bezel, 7 Volt, bezel red, Solder terminal



### fields of application

- > Measurement-control-regulation
- > Electrical engineering
- > Mechanical and system engineering
- > Signalling systems
- > Model construction



### description

Signal lamps with integrated LED, mounting hole diameter 5 mm

### technical data

#### > general

Bezel color	red
Property of bezel / mushroom	transparent
Bezel shape	round
illuminated	Yes
Packaging unit	10 pcs.
net weight	0.5 g
Degree of protection, front side, according to DIN EN 60529	IP40
MOQ order	50 pcs.
RoHS compliant	Yes
REACH compliant	Yes

#### direct links

- > [RAFI eCatalog](#)

#### > mounting diameters

Outside dimension, length	5.9 mm
Outside dimension, width	5.9 mm
Outside dimension, height	22 mm
Mounting hole	5 mm
Mounting depth	18 mm
Installation height	1 mm
Collar dimension	5.8 mm

#### > mechanical data

The information in this data sheet only contains general descriptions and / or performance features, which may not apply precisely as described to the respective application, and which may change due to further product enhancements. The technical data, illustrations and other information about our products are the mere results of individual technical testing. These descriptions and other product features are only binding if they expressly agreed upon at the time of the conclusion of a binding contract. In all other cases, we reserve the right to make technical changes as well as changes of availability. Pictures and other graphic illustrations are approximations only. All product names may be trademarks or brand names of the RAFI Group or any other sub-supplier of RAFI. The use of such by any third parties for their own purposes may infringe the rights of the respective entity holding those rights.

date: Jul 27, 2024 page: 1/3

#### RAFI GmbH & Co. KG

Ravensburger Str. 128-134  
88276 Berg / Ravensburg  
Germany  
[www.rafi-group.com](http://www.rafi-group.com),  
[info.headquarters@rafi-group.com](mailto:info.headquarters@rafi-group.com)

Fixing	Pushing into mounting hole
Solderability	Yes
Terminal on the rear	Solder terminal

**> electrical data**

Operating voltage of the luminous element, min.	5 V
Operating voltage of the luminous element, max.	7 V

**drawings**

**Dimensioned drawing**

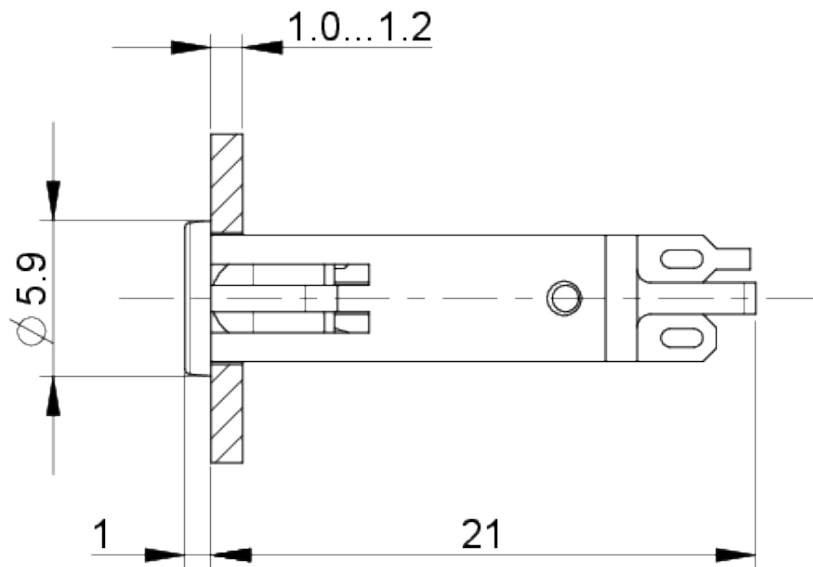

**Mounting hole drawing**

