

MICON 5, ring lighting plunger, D 20.7 mm



fields of application

- › Measurement-control-regulation
- › Mechanical and system engineering
- › Automotive
- › Signalling systems
- › Vehicle construction
- › Handheld terminals

description

The wide selection of standard plungers in different shapes and colors guarantees a versatile range of applications for the MICON 5 tactile switch.

The non-illuminated standard plunger is already included in the scope of delivery for ring illumination.

technical data

› general

illuminated	Yes
Packaging unit	100 pcs.
net weight	1.9 g
MOQ order	100 pcs.
RoHS compliant	Yes
REACH compliant	Yes

direct links

- › [RAFI eCatalog](#)

› mounting diameters

Outside dimension, length	10.8 mm
Outside dimension, width	20.7 mm
Outside dimension, height	20.7 mm

drawings

Dimensioned drawing

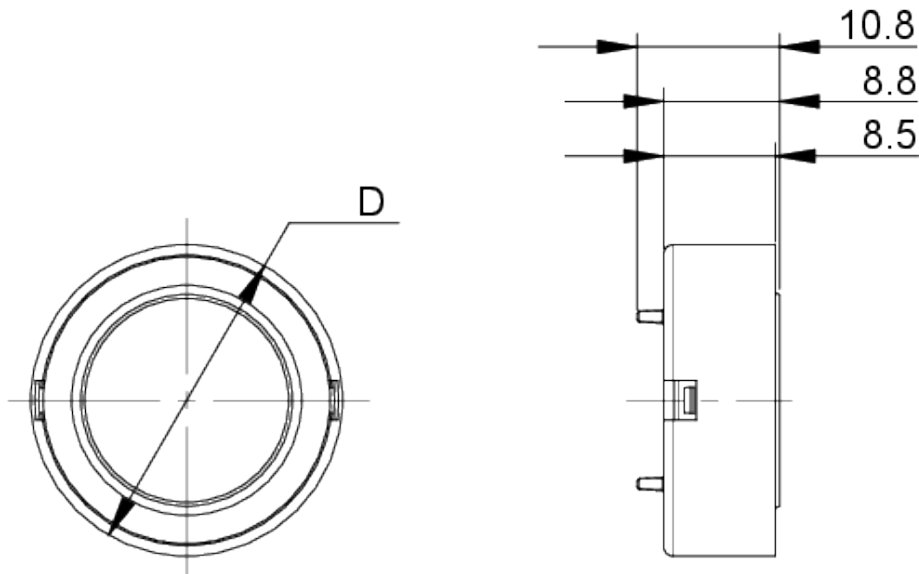

System drawing

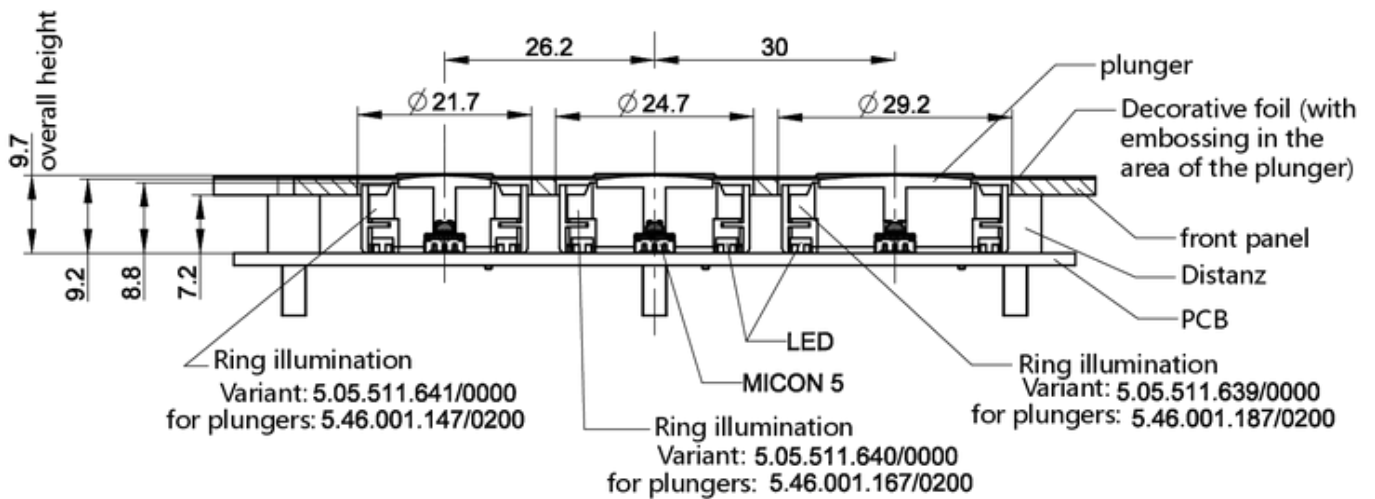

PCB drawing

