

MICON 5, square plunger 14.5 mm, mechanical stop limit, red, GH 9.55 mm



fields of application

- > Measurement-control-regulation
- > Mechanical and system engineering
- > Automotive
- > Signalling systems
- > Vehicle construction
- > Handheld terminals

description

The wide selection of standard plungers in different shapes and colors guarantees a versatile range of applications for the MICON 5 tactile switch.

technical data

> general

Bezel color	red
illuminated	Yes
Packaging unit	100 pcs.
net weight	0.9 g
MOQ order	100 pcs.
RoHS compliant	Yes
REACH compliant	Yes

direct links

- > [RAFI eCatalog](#)

> mounting diameters

Outside dimension, length	8.7 mm
Outside dimension, width	14.5 mm
Outside dimension, height	14.5 mm
Plunger length L	6.2 mm
Support height A	3.35 mm
Total height GH	9.55 mm

drawings

Dimensioned drawing

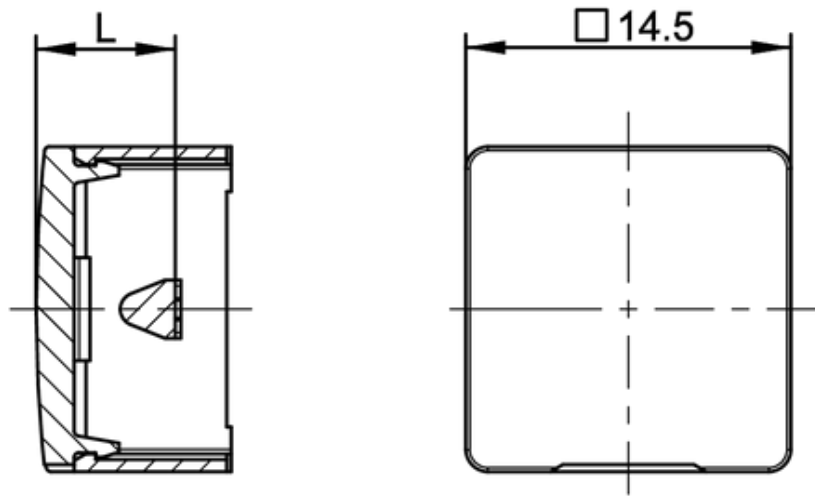

System drawing

Structure:
High embossing 0.35 mm
Adhesive thickness 0.15 mm

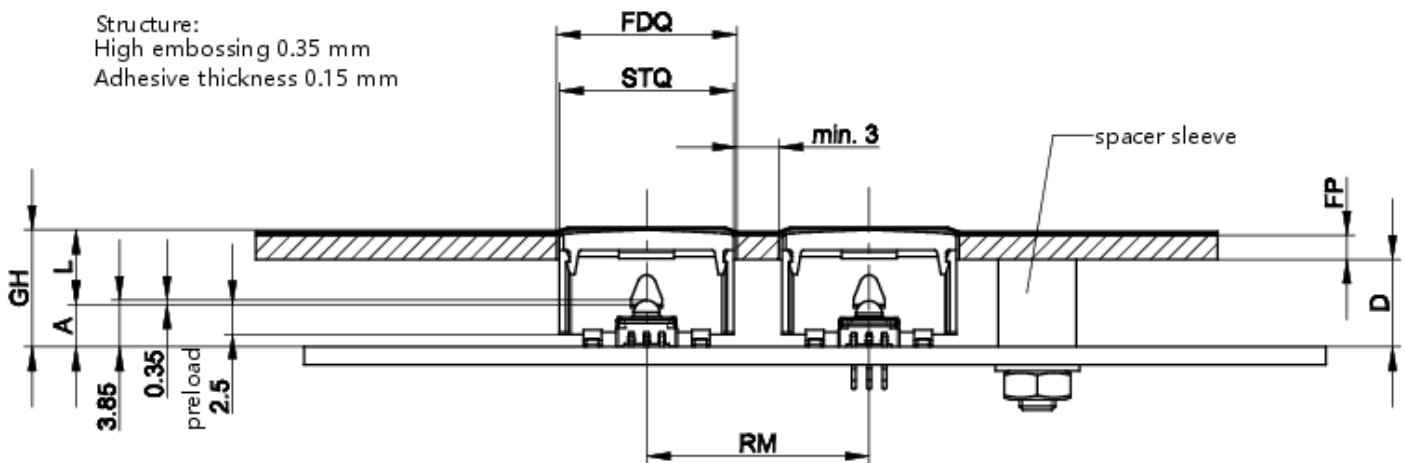

$GH=A+L$

PCB drawing

View without front panel,
foil and screen

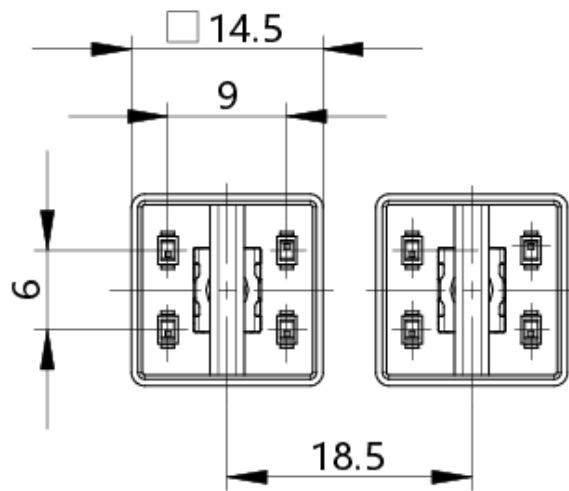

Illustration with 4 LED OSRAM LO M676-Q1R1-24

PCB drawing

View without front panel,
foil and screen

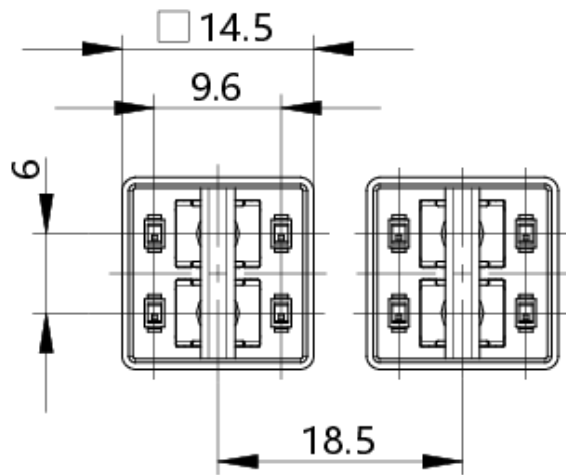

Illustration with 4 LED OSRAM LO M676-Q1R1-24