

RACON, round plunger 14.5 mm, L 2.9 mm



fields of application

- › Measurement-control-regulation
- › Mechanical and system engineering
- › Automotive
- › Signalling systems
- › Vehicle construction
- › Handheld terminals

description

The wide selection of standard plungers in different shapes and colors guarantees a versatile range of applications for the RACON tactile switch.

technical data

› general

Color	white
Collar shape	round
illuminated	No
Packaging unit	500 pcs.
net weight	0.2 g
MOQ order	1,000 pcs.
RoHS compliant	Yes
REACH compliant	Yes
Component material	Plastic

direct links

- › [RAFI eCatalog](#)

› mounting diameters

Outside dimension, length	4.4 mm
Outside dimension, width	14.5 mm
Outside dimension, height	14.5 mm
Plunger length L	2.9 mm

drawings

Dimensioned drawing

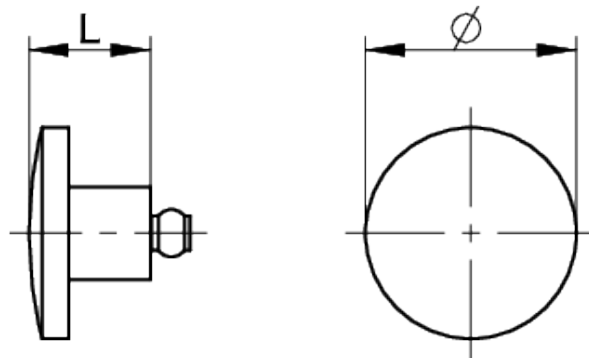

System drawing

SMT gullwing connection

Recommended: Embossing: 0.35 mm

Adhesive thickness: 0.15 mm

