

RACON, round plunger 14.5 mm, L 7.6 mm



fields of application

- > Measurement-control-regulation
- > Mechanical and system engineering
- > Automotive
- > Signalling systems
- > Vehicle construction
- > Handheld terminals

description

The wide selection of standard plungers in different shapes and colors guarantees a versatile range of applications for the RACON tactile switch.

technical data

> general

| | |
|--------------------|------------|
| Color | white |
| Collar shape | round |
| illuminated | No |
| Packaging unit | 500 pcs. |
| net weight | 0.2 g |
| MOQ order | 1,000 pcs. |
| RoHS compliant | Yes |
| REACH compliant | Yes |
| Component material | Plastic |

direct links

- > [RAFI eCatalog](#)

> mounting diameters

| | |
|---------------------------|---------|
| Outside dimension, length | 9.1 mm |
| Outside dimension, width | 14.5 mm |
| Outside dimension, height | 14.5 mm |
| Plunger length L | 7.6 mm |

drawings

Dimensioned drawing

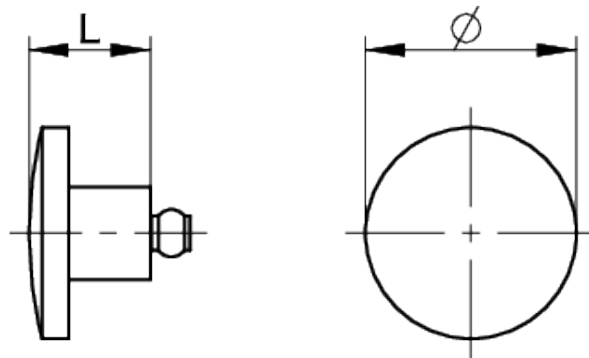

System drawing

SMT gullwing connection

Recommended: Embossing: 0.35 mm

Adhesive thickness: 0.15 mm

