

## E-BOX modular, housing, 35 V, 22.3 mm, M16 to the side, light gray



### fields of application

- › Measurement-control-regulation
- › Mechanical and system engineering
- › Construction machinery
- › Industrial robots
- › Model construction
- › Home technology

### special features

- › Kompakte Abmessungen: 109 x 40 x 27 mm
- › Für Betätiger der Befehlsgeräte-Baureihe RAFIX 22 FS+ (Einbaudurchmesser ø 22,3 mm)
- › Schaltelemente mit 2 Kontakten (für Not-Halt „PLUS1“ mit 3 Kontakten)
- › Optional mit LED für beleuchtbare Betätigungselemente
- › Mit gelbem Gehäuseoberteil für Not-Halt-Betätiger
- › Mit grauem Gehäuseoberteil für Standard-Betätiger wie z.B. Drucktaster
- › Befestigung mit zeitsparender Ein-Loch-Schraubbefestigungstechnik, besonders geeignet für Aluprofilschienen oder alternativ Direktbefestigung mit M4 Schrauben
- › Inklusive Kabeleinführung für Direktverkabelung: seitlich M16 oder bodenseitig M20



## description

The elegant and flat E-BOX is the complete housing for RAFIX 22 FS+ control units. It is used where individual control devices are required at remote locations - for example, emergency stop applications along a production facility or at a safety fence. The compact dimensions of the E-BOX are based on the edge dimensions of a 40 mm profile rail. Installation is also designed with this in mind. This is quick and easy thanks to the modular system consisting of a lower and upper housing section, contact module with switching element and emergency stop actuator.

## technical data

### › general

Color	light gray
Operating temperature, min.	-25 °C
Operating temperature, max.	70 °C
Storage temperature, min.	-40 °C
Storage temperature, max.	80 °C
Packaging	Box
Packaging unit	1 pcs.

### direct links

- › [RAFI eCatalog](#)

net weight	100.8 g
Degree of protection, front side, according to DIN EN 60529	IP65
Degree of protection, rear side, according to DIN EN 60529	IP65
Protection class	II
MOQ order	10 pcs.
RoHS compliant	Yes
REACH compliant	Yes
<b>&gt; mounting diameters</b>	
Outside dimension, length	108,6 mm
Outside dimension, width	40 mm
Outside dimension, height	27 mm
Mounting hole	22.3 mm
<b>&gt; mechanical data</b>	
Fixing	Assembly clip
Terminal on the rear	M16 to the side
<b>&gt; electrical data</b>	
Operating voltage, max.	35 V

**drawings**

**Dimensioned drawing**

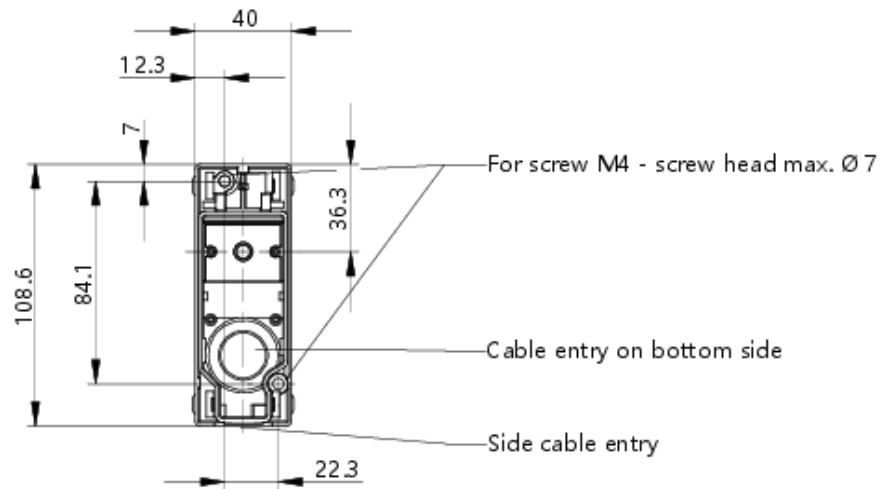

**System drawing**

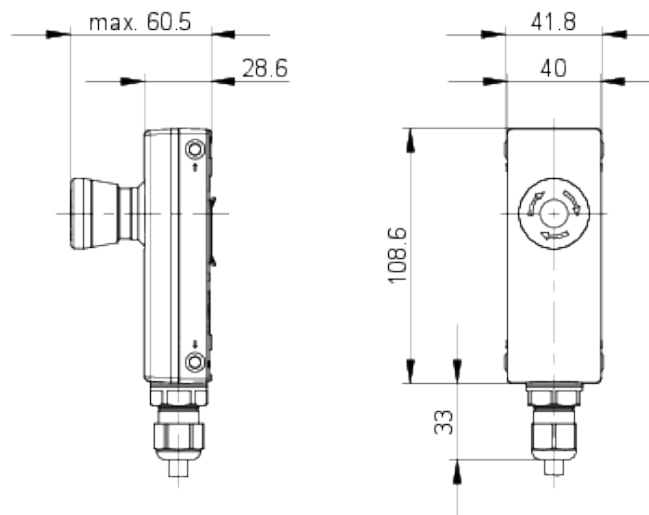

**System drawing**

