

RAFIX 22 FS⁺, keylock switch, square collar, frontring green, 2 x 40°, momentary contact function, key removal position 0

LBL_NRFND



fields of application

- > Measurement-control-regulation
- > Electrical engineering
- > Mechanical and system engineering
- > Vehicle construction
- > Handheld terminals
- > Industrial robots

special features

- > Key switch standard
- > Low installation depth 9.2 mm (PCB) or 27 mm (QC)
- > Connection types: printed circuit board connection (PCB) or plug-in connection (QC)
- > PCB switching elements minimize mounting errors
- > Switching elements with silver contacts (max. 250 V/4 A) or gold contacts (max. 35 V/100 mA)
- > Design adaptation through different front ring variations
- > Degree of protection: IP 65 at the front
- > Two collar shapes: round and square



description

RAFIX control devices are defined at RAFI as modular elements, consisting of an actuating element, if necessary a coupling and an individual contact or lighting unit.

Actuating elements (such as pushbuttons, emergency stop actuators, etc.) have the intended tactility, reset and function only when assembled with the appropriate switching elements.

The locking systems we use have been created by reputable lock manufacturers in accordance with the DIN EN 1303 standard. They are open, mechanical systems that require occasional maintenance by the operator depending on the ambient conditions.

Further locking positions or functions are available on request.

technical data

> general

Disassembly possible	no
Scope of delivery	2 keys
Front ring color	green
Collar shape	square
Operating temperature, min.	-25 °C
Operating temperature, max.	70 °C

direct links

- > [RAFI eCatalog](#)

Storage temperature, min.	-40 °C
Storage temperature, max.	80 °C
illuminated	No
Packaging	Box
Operating life	300,000 cycles
B10	390,000 cycles
Degree of protection, front side, according to DIN EN 60529	IP65
UL Enclosure Type Rating front side	type 1 type 4X indoor
Environment resistance	IEC 60068-2-14 IEC 60068-2-30 IEC 60068-2-33 IEC 60068-2-78
Salt-spray resistance according to standard	IEC 60068-2-11
RoHS compliant	Yes
REACH compliant	Yes
> mounting diameters	
Outside dimension, length	29.8 mm
Outside dimension, width	29.8 mm
Mounting hole	22.3 mm
Mounting depth	9.2 mm
Installation height	25.2 mm
Grid, min.	30 x 30 mm
Collar dimension	29,8 x 29,8 mm
> mechanical data	
Actuation function	momentary contact function
Operating torque, max.	1.3 Nm
Locking position	1
Key removal position	0
Rotating angle	2 x 40°
Fixing	Threaded ring
Threaded ring torque, max.	1.2 Nm

drawings

Dimensioned drawing

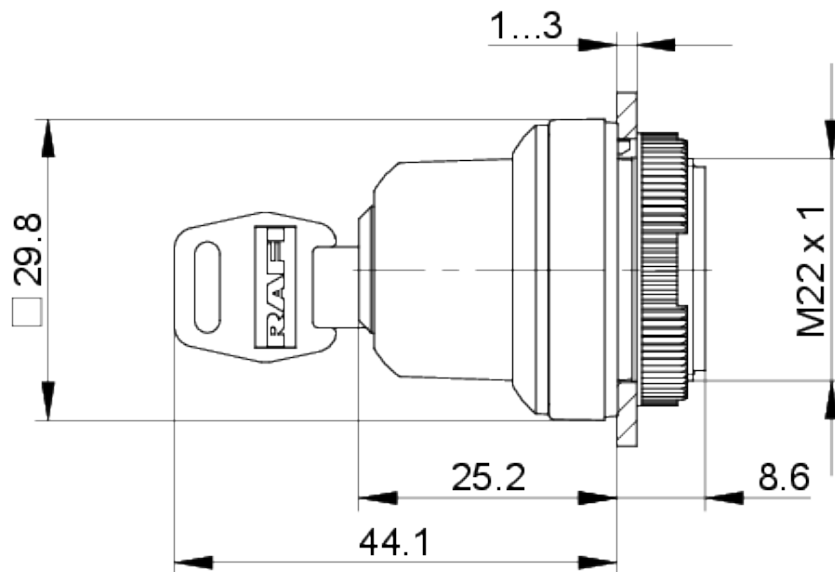

System drawing

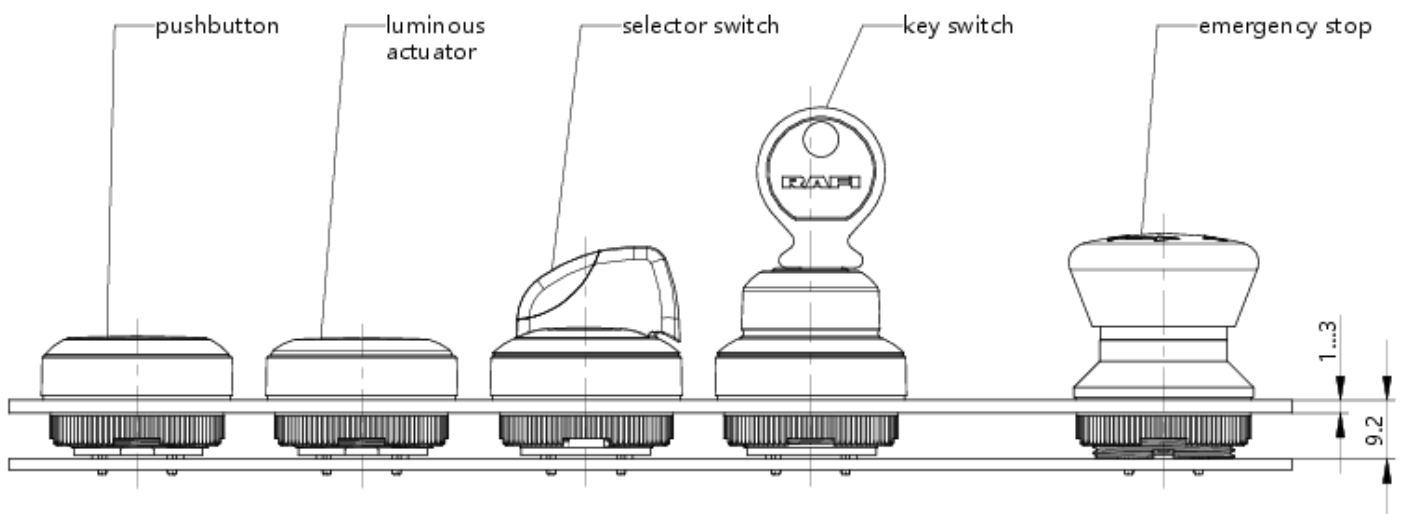

System drawing



Mounting hole drawing



acc. to IEC 60947-5-1

front panel drawing

