

RAFIX 22 FS⁺, illuminated selector switch, square collar, frontring blue, 2 x 40°, momentary contact function, illuminable



fields of application

- › Measurement-control-regulation
- › Electrical engineering
- › Mechanical and system engineering
- › Vehicle construction
- › Handheld terminals
- › Industrial robots

special features

- › Illumination of the rotary handle marking with SMT LED
- › Colored illumination with colored LEDs possible
- › Low installation depth 9.2 mm (PCB) or 27 mm (QC)
- › Connection types: printed circuit board connection (PCB) or plug-in connection (QC)
- › PCB switching elements minimize mounting errors
- › Switching elements with silver contacts (max. 250 V/4 A) or gold contacts (max. 35 V/100 mA)
- › Design adaptation through different front ring variations
- › Degree of protection: IP 65 at the front
- › Two collar shapes: round and square



description

RAFIX control devices are defined at RAFI as modular elements, consisting of an actuating element, if necessary a coupling and an individual contact or lighting unit.

Actuating elements (such as pushbuttons, emergency stop actuators, etc.) have the intended tactility, reset and function only when assembled with the appropriate switching elements.

The translucent handle marking can be illuminated if combined with a corresponding switching element.

For colored illumination of the handle marking, please use colored LEDs.

technical data

› general

Disassembly possible	no
Front ring color	blue
Collar shape	square
Operating temperature, min.	-25 °C

direct links

- › [RAFI eCatalog](#)

Operating temperature, max.	70 °C
Storage temperature, min.	-40 °C
Storage temperature, max.	80 °C
illuminated	Yes
Packaging	Box
Operating life	500,000 cycles
B10	650,000 cycles
Degree of protection, front side, according to DIN EN 60529	IP65
UL Enclosure Type Rating front side	type 1 type 4X indoor
Environment resistance	IEC 60068-2-14 IEC 60068-2-30 IEC 60068-2-33 IEC 60068-2-78
Salt-spray resistance according to standard	IEC 60068-2-11
RoHS compliant	Yes
REACH compliant	Yes
> mounting diameters	
Outside dimension, length	29.8 mm
Outside dimension, width	29.8 mm
Outside dimension, height	32.4 mm
Mounting hole	22.3 mm
Mounting depth	9.2 mm
Installation height	22.24 mm
Grid, min.	30 x 30 mm
Collar dimension	29,8 x 29,8 mm
> mechanical data	
Actuation function	momentary contact function
Operating torque, max.	1.5 Nm
Rotating angle	2 x 40°
Fixing	Threaded ring
Threaded ring torque, max.	1.2 Nm

drawings

Dimensioned drawing

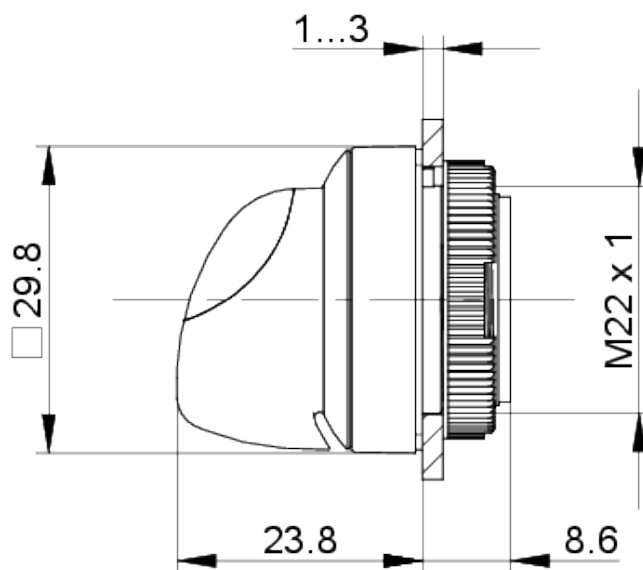

System drawing



System drawing



Mounting hole drawing



acc. to IEC 60947-5-1

front panel drawing

