

TILTED DIAMOND+ support tube, black, L 400 mm



description

The holder tubes in various lengths and shapes, together with the mounting base, enable diverse mounting options for the TILTED DIAMOND+ variants. The mounting tubes are also used for the KIS.LIGHT and the TILTED DIAMOND+ IO-LINK. This allows the signal lights to be mounted easily and clearly even in remote or out-of-the-way locations.

The mounting tubes are connected to the mounting base by a threaded pin. The material is black coated steel. The holder tubes and the mounting base have environmental resistance, which is certified according to IEC 60068-2.

technical data

> general

Color	black
Packaging unit	1 pcs.
net weight	485 g
Environment resistance	IEC 60068-2-27 IEC 60068-2-64
MOQ order	1 pcs.
RoHS compliant	Yes
REACH compliant	Yes
Component material	Metall

direct links

> [RAFI eCatalog](#)

> mounting diameters

Outside dimension, length	400 mm
Outside dimension, width	46 mm

> mechanical data

Fixing	Screw
--------	-------

drawings

Dimensioned drawing

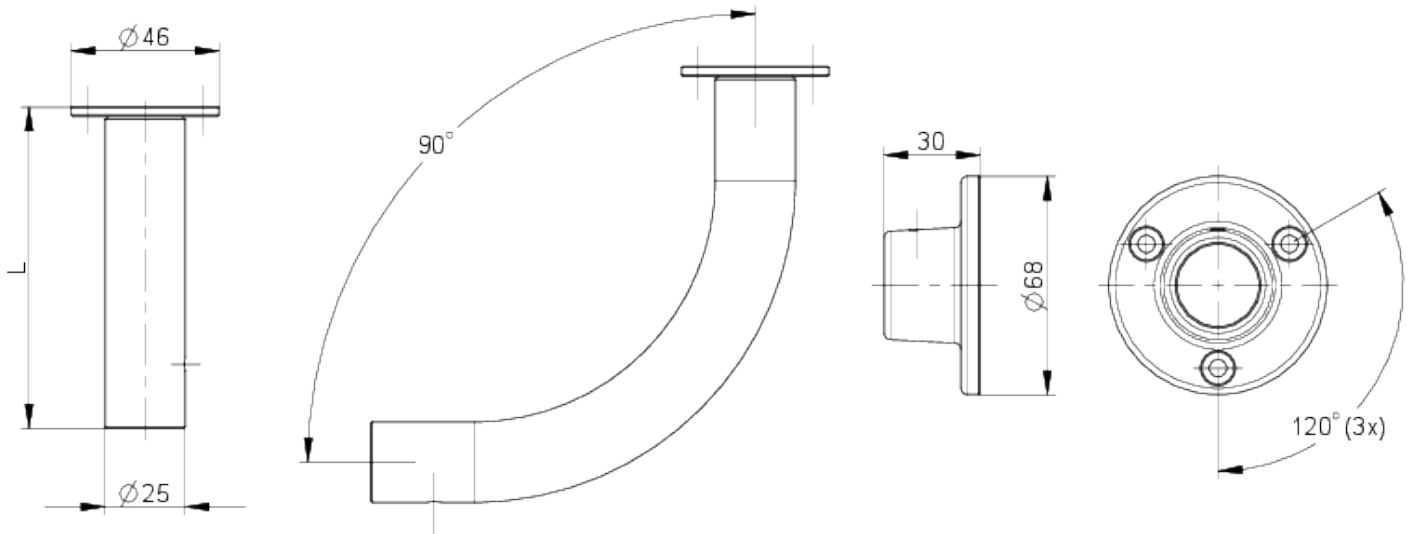

System drawing

