

GET IN
TOUCH

RAFI 22 FSR

When the going gets tough, the tough get going!



CONTROL COMPONENTS

RAFIX 22 FSR CONTROL COMPONENTS

RAFIX 22 FSR

WHEN THE GOING GETS TOUGH

Harsh weather conditions. Dirt and dust are swirling around, and the sun is beating down mercilessly. It's critical to keep pushing ahead – fast. A dirty glove dripping with lubricants pounds a key vigorously, and work goes on!

The cloud cover is increasing, it's raining, the temperature drops below the freezing point and it starts sleeting. Ice crystals stick to the operating elements, but the machinery keeps on running. Dust, dirt, lubricants, moisture, heat and

cold: Close to the limit, solutions are required which are extremely rugged, hard-wearing and tough-natured. RAFIX 22 FSR has taken on this challenge. Under the most adverse conditions, these actuators and contact blocks demonstrate their strengths: ruggedness and know-how based on proven FS technology. A series specifically developed for outdoor applications.



Close to the limit

Robust, economical, and extremely efficient! RAFIX 22 FSR is based on tried-and-tested FS technology and a robust design. The contact blocks have a low mounting depth, which saves an enormous amount of space and enables fast installation. The pushbuttons and actuators ensure quick orientation along with a highly distinctive design thanks to their individually combinable colors and shapes.

The top performer

Dirt: No matter whether it is exposed to industrial lubricants or soiling which occurs naturally during outdoor use – the series is extremely resistant and delivers what it promises.

Rugged: The actuator mechanism is not affected even by harsh conditions and severe external impacts.

Climate: Intense sunlight, heavy rain, hail or snow – RAFIX 22 FSR easily withstands adverse weather conditions.

Moisture: Waterproof actuators ensure dependable operation.

SLIM

- Designs with PCB contact blocks feature a distance between the front panel and printed circuit board of only 9.2 mm.
- With QC contact blocks, only 27 mm of space is needed behind the front panel.

Combinable with all contact blocks and accessories with RAFIX FS technology

- PCB or QC contact blocks
- Gold contacts from 5 V or silver contacts up to 250 V
- Short-travel adapter enables short-travel actuation (1 mm switching travel) with perceptible key click
- Variable illumination, compatible with 3 mm THT LEDs / SMT LEDs or LED clip



RAFIX 22 FSR

The RAFIX 22 FSR series has a variety of actuators and signal indicators

Pushbuttons

- Illuminable
- With protective cap

Emergency stop

- Unlocked by pulling
- Illuminated (optional)
- Metal version (optional)

Selector switches

- Rotating angle 40°, 60° or 90°
- Latching or momentary
- Illuminable

Keylock switches

- Rotating angle 40° or 90°
- Latching or momentary
- With protective cap

Signal indicators

- Green, yellow, red, blue or white

Approvals

- IEC 60947-5-1/5
- UL
- CCC

Safe and reliable

The actuators in the RAFIX 22 FSR series ensure a degree of protection to at least IP65 (DIN EN 60529), which makes them suitable for many diverse applications.

Long operating life

The mechanical design of all actuators is suited for operation in heavily used panels.

Mounting hole

The actuators in the RAFIX 22 FSR series are suitable for 22.3 mm panel cut-outs according to IEC 60947-5-1.

All actuators are equipped with a locating pip. This locating pip ensures a perfect fit for actuators and contact blocks with PCB-mounted components and is therefore essential for designs including these contact blocks.

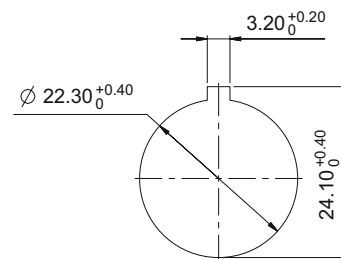

Grid spacing

The design principle makes it possible to use a minimum grid spacing of 35 mm x 35 mm.

When choosing the grid spacing, it is recommended to consider any external legending required (for example, using label strips inserted into the front panel).



CONTROL COMPONENTS

RAFIX 22 FSR CONTROL COMPONENTS

RAFIX 22 FSR

RAFIX 22 FSR with PCB contact block

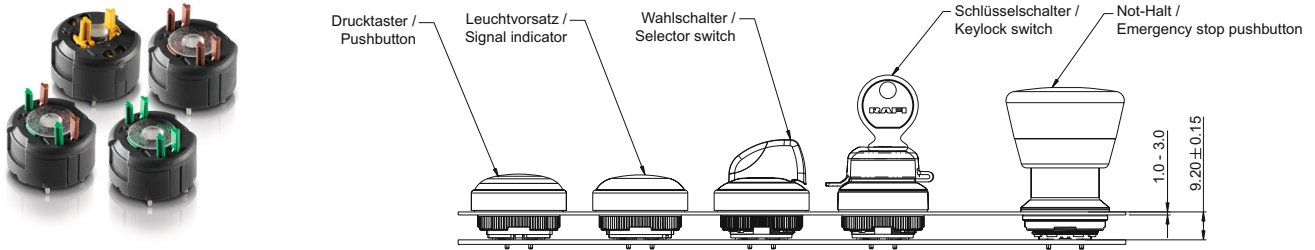

For printed circuit board hole patterns, see RAFIX 22 FS-Technology contact blocks

Formula for spacer length

$$\frac{9.2 \text{ mm} - \text{Front panel thickness}}{\text{Length of spacer}}$$

RAFIX 22 FSR with QC contact block

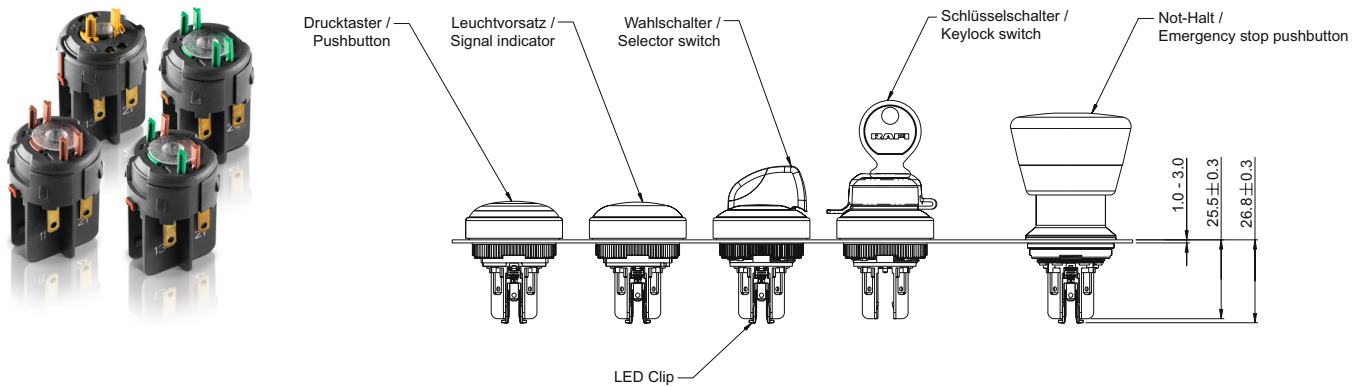

To find matching switching elements and accessories, see the "RAFIX FS Technology" section of our "Electromechanical Components" catalog online. You can also download the catalog from the download center on our website.

RAFIX 22 FSR Pushbuttons

→ The RAFIX 22 FSR pushbutton is equipped with a protective cap. The pushbutton is resistant to external impacts and offers a degree of protection to IP65 and/or IP69K as per IEC 60529, which means protection against the ingress of water when highly pressurized water/steam jet cleaners are used at a pressure of 80 – 100 bar.



Technical Data

→ General information

Form of lens	flush
Color of lens	see order block
Color of front ring	black
Form of collar	round

→ Dimensions

Dimensions of collar	Ø 31.3 mm
Overall height	12.2 mm
Mounting hole	22.3 mm
Key grid	35 x 35 mm

→ Mechanical design

Mounting	ring nut
Contact function	momentary
Illuminability	see order block
Torque for nut ring	1.2 Nm

→ Mechanical characteristics

Operating travel	4 mm
Robustness max.	100 N

→ Other specifications

Ambient temp. operating min.	-40 °C
Ambient temp. operating max.	+85 °C
Storage temperature min.	-40 °C
Storage temperature max.	+85 °C
Degree of protection from front side	IP65 (DIN EN 60529)
Environmental resistance	acc. to IEC 60068-2-14, -30, -33 and -78
Salt spray	IEC 600 68-2-11
ROHS compliant	yes
REACH compliant	yes

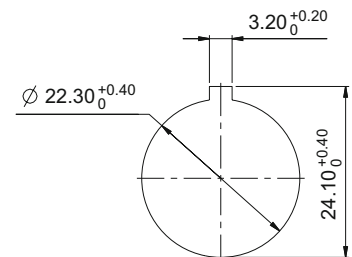
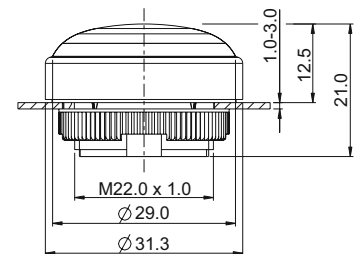

Panel cut-out to IEC 60947-5-1

Approvals







Accessories RAFIX 22 FSR - Pushbuttons

→ Description	Photo	Order no.	Additional accessories see page
RAFIX FS - Contact block PCB gold, Universal		-	-
RAFIX FS - Contact block PCB gold, Universal, with light conductor		-	-

CONTROL COMPONENTS

RAFIX 22 FSR - ACTUATORS

**- Table (continued) -
Accessories RAFIX 22 FSR - Pushbuttons**

→ Description	Photo	Order no.	Additional accessories see page
RAFIX FS - Contact block PCB silver, Universal		-	-
RAFIX FS - Contact block PCB silver, Universal, with light conductor		-	-
RAFIX FS - Contact block QC gold, Universal, with light conductor"		-	-
RAFIX FS - Contact block QC silver, Universal, with light conductor		-	-
Fixing spanner for ring nut		5.05.800.062/0000	-



RAFIX 22 FSR Pushbutton

Technical data see page 5

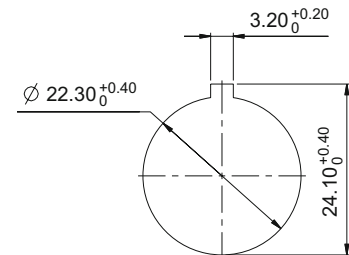
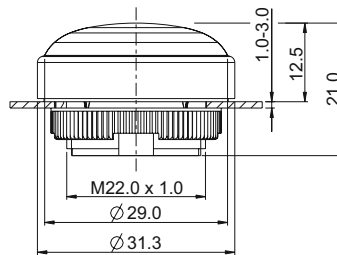

Panel cut-out to IEC 60947-5-1

→ Illuminability	Color of lens	Order no.
yes	translucent red	1.30.280.001/2301
yes	translucent yellow	1.30.280.001/2401
yes	translucent green	1.30.280.001/2501
yes	translucent blue	1.30.280.001/2601
yes	translucent white	1.30.280.001/2201
no	opaque black	1.30.280.001/0101

Legending and front rings in other colors on request

RAFIX 22 FSR Selector switches

→ The marks on the selector switch turning handle are translucent and can be illuminated if required. Colored LEDs or LED clips can be used for colored illuminations.



Technical Data

→ General information

Actuator	handle
Marking of handle	see order block
Color of front ring	black
Form of collar	round

→ Dimensions

Dimensions of collar	Ø 31.3 mm
Overall height	23.8 mm
Mounting hole	22.3 mm
Key grid	35 x 35 mm

→ Mechanical design

Mounting	ring nut
Contact function	see order block
Illuminability	yes
Rotating angle	see order block
Torque for nut ring	1.2 Nm

→ Mechanical characteristics

Torque max.	2 Nm
-------------	------

→ Other specifications

Degree of protection from front side	IP65 (DIN EN 60529); IP69K (ISO 20653)
Ambient temp. operating min.	-40 °C
Ambient temp. operating max.	+85 °C
Storage temperature min.	-40 °C
Storage temperature max.	+85 °C
Environmental resistance	acc. to IEC 60068-2-14, -30, -33 and -78
Salt spray	IEC 600 68-2-11
ROHS compliant	yes
REACH compliant	yes

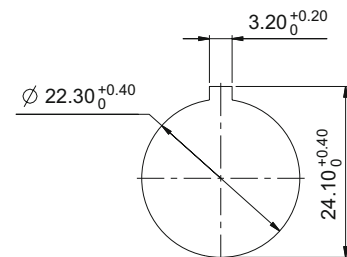
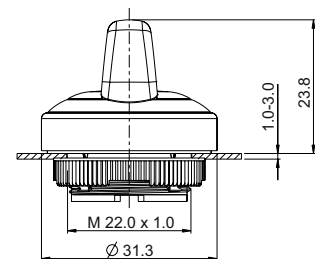

Panel cut-out to IEC 60947-5-1

Approvals



Accessories RAFIX 22 FSR - Selector switches

Description	Photo	Order no.	Additional accessories see page
RAFIX FS - Contact block PCB gold, Universal, with light conductor		-	2 - 242
RAFIX FS - Contact block PCB silver, Universal, with light conductor		-	2 - 247
RAFIX FS - Contact block QC gold, Universal, with light conductor		-	2 - 253
RAFIX FS - Contact block QC silver, Universal, with light conductor		-	-
Fixing spanner for ring nut		5.05.800.062/0000	-

CONTROL COMPONENTS

RAFIX 22 FSR - ACTUATORS



RAFIX 22 FSR Selector switch

Technical data see page 7

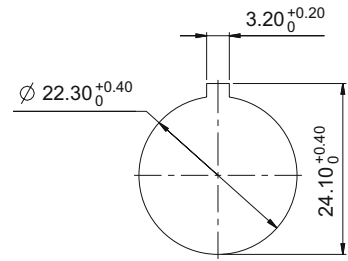
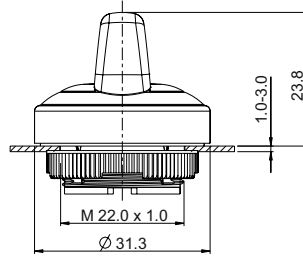

Panel cut-out to IEC 60947-5-1

→ Illuminability	Contact function	Rotating angle		Order no.
yes	momentary	1 x 40°		1.30.282.001/2201
yes	momentary	2 x 40°		1.30.282.026/2201
yes	latching	1 x 90°, L shape		1.30.282.101/2201
yes	latching	1 x 90°, V shape		1.30.282.201/2201
yes	latching	2 x 60°		1.30.282.301/2201

RAFIX 22 FSR Keylock switches

→ The RAFIX 22 FSR keylock switches are equipped with a plastic protective cap which protects against dirt, water and danger of icing when it is closed. Two keys respectively are included in the delivery.

The locking systems we use were created according to DIN EN 1303 by leading lock manufacturers. They are open, mechanical systems that require occasional maintenance of the machinery or plant operator depending on environmental conditions.

Two keys are included.



Technical Data

→ General information

Color of front ring	black
Form of collar	round

→ Dimensions

Dimensions of collar	Ø 31.3 mm
Overall height	45.1 mm
Mounting hole	22.3 mm
Key grid	35 x 35 mm

→ Mechanical design

Mounting	ring nut
Contact function	see order block
Illuminability	no
Wafers	5
Lock type	001
Main key	on request
Rotating angle	see order block
Key removal position	see order block
Torque for nut ring	1.2 Nm

→ Mechanical characteristics

Torque max.	1.3 Nm
-------------	--------

→ Other specifications

Degree of protection from front side	IP65 (DIN EN 60529); IP69K (ISO 20653)
water temp.	23 °C +- 3 °C
Ambient temp. operating min.	-40 °C
Ambient temp. operating max.	+85 °C
Storage temperature min.	-40 °C
Storage temperature max.	+85 °C
Environmental resistance	acc. to IEC 60068-2-14, -30, -33 and -78
Salt spray	IEC 600 68-2-11
ROHS compliant	yes
REACH compliant	yes

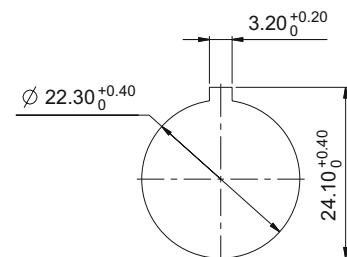
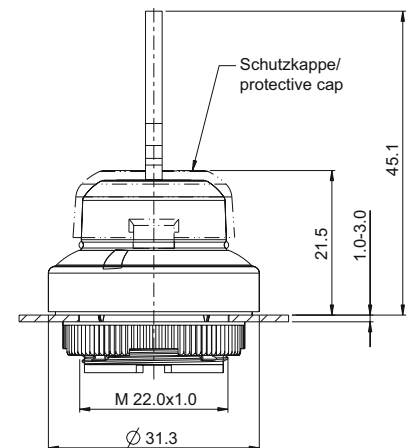

Panel cut-out to IEC 60947-5-1





Approvals



CONTROL COMPONENTS

RAFIX 22 FSR - ACTUATORS

Accessories RAFIX 22 FSR - Keylock switches

→ Description	Photo	Order no.	Additional accessories see page
RAFIX FS - Contact block PCB gold, Universal		-	-
RAFIX FS - Contact block PCB silver, Universal		-	-
RAFIX FS - Contact block QC gold, Universal, with light conductor		-	-
RAFIX FS - Contact block QC silver, Universal, with light conductor		-	-
Fixing spanner for ring nut		5.05.800.062/0000	-





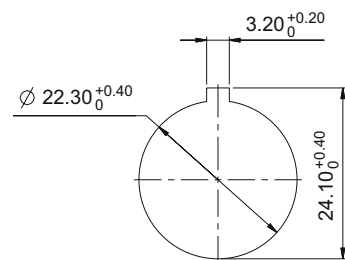
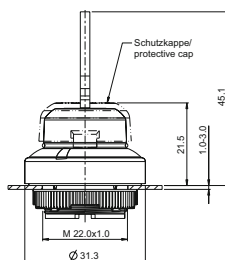

RAFIX 22 FSR Keylock switch

Technical data see page 9



Panel cut-out to IEC 60947-5-1

→ Contact function	Rotating angle		Key removal position	Order no.
momentary	1 x 40°		0	1.30.285.001/0100
momentary	2 x 40°		0	1.30.285.101/0100
latching	1 x 90°, L shape		0+1	1.30.285.221/0100
latching	1 x 90°, V shape		0+1	1.30.285.321/0100

RAFIX 22 FSR Emergency stop pushbuttons

→ The emergency stop pushbuttons comply with IEC 60 204, IEC 60 073, IEC 60 947, and VDE 0113 part 1. The positively guided mechanical movement of the pushbuttons makes them dupe-proof according to DIN EN ISO 13850. To prevent accidental actuation, the pushbutton has a pressure point which must be pressed first before the pushbutton snaps into place in the pressed position.

The emergency stop pushbutton is non-blocking thanks to the actuator's design. For example, an initiated emergency stop procedure cannot be interrupted by jammed objects. Use only with an emergency stop contact block.

Original manual see chapter 6, RAFI catalog „Electromechanical Components“

Technical Data

→ General information

Form of lens	conical mushroom form
Color of lens	red
Form of collar	round

→ Dimensions

Mushroom Diameter	37.5 mm
Overall height	41.1 mm
Mounting hole	22.3 mm
Key grid	40 x 40 mm

→ Mechanical design

Mounting	metal threaded rings
Contact function	latching
Reset	by pulling
Illuminability	see order block
Torque for nut ring	1.2 Nm

→ Mechanical characteristics

Robustness max.	100 N
	750 N static

→ Other specifications

Degree of protection from front side	IP65 (DIN EN 60529)
Ambient temp. operating min.	-40 °C
Ambient temp. operating max.	+85 °C
Storage temperature min.	-40 °C
Storage temperature max.	+85 °C
Environmental resistance	acc. to IEC 60068-2-14, -30, -33 and -78
Salt spray	IEC 600 68-2-11
ROHS compliant	yes
REACH compliant	yes

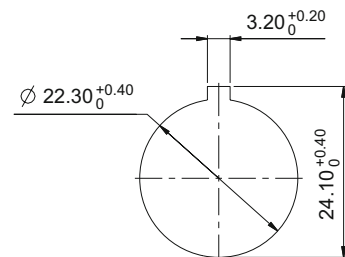
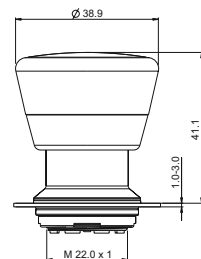

Panel cut-out to IEC 60947-5-1









Approvals



CONTROL COMPONENTS

RAFIX 22 FSR - ACTUATORS

Accessories RAFIX 22 FSR - Emergency stop pushbuttons

→ Description	Photo	Order no.	Additional accessories see page
Emergency stop label, Ø 22.3 mm		-	-
RAFIX FS - Contact block PCB gold, E-Stop		-	-
RAFIX FS - Contact block PCB gold, E-Stop, with light conductor		-	-
RAFIX FS - Contact block PCB silver, E-Stop		-	-
RAFIX FS - Contact block PCB silver, E-Stop, with light conductor		-	-
RAFIX FS - Contact block QC gold, E-Stop, with light conductor		-	-
RAFIX FS - Contact block QC silver, E-Stop, with light conductor		-	-
Fixing spanner for ring nut		5.05.800.062/0000	-



RAFIX 22 FSR Emergency stop pushbutton, metal mushroom

Technical data see page 11

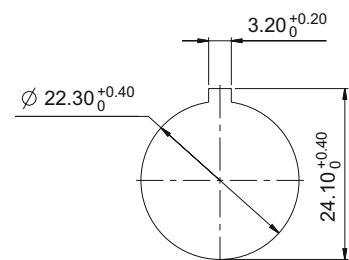
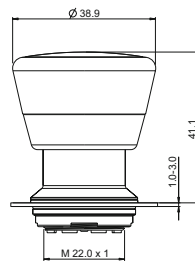

Panel cut-out to IEC 60947-5-1

→ Illuminability	Degree of protection from front side	Order no.
yes, window white	IP65 (DIN EN 60529)	1.30.283.111/0300
no	IP65 (DIN EN 60529)	1.30.283.611/0300

RAFIX 22 FSR Emergency stop pushbutton, plastic mushroom

Technical data see page 11

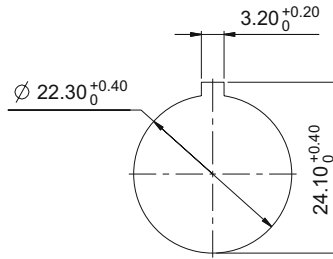
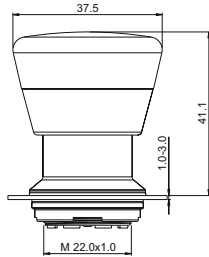

→ Illuminability	Degree of protection from front side	Order no.
yes, window white	IP65 (DIN EN 60529)	1.30.283.101/0300
no	IP65 (DIN EN 60529)	1.30.283.601/0300



RAFIX 22 FSR Signal indicators

→ The RAFIX 22 FSR lenses are designed for illumination with SMT or THT LEDs. They guarantee full area illumination.

Technical Data

→ General information

Color of lens	see order block
Form of collar	round

→ Dimensions

Mounting hole	22.3 mm
Key grid	35 x 35 mm

→ Mechanical design

Mounting	ring nut
Illuminability	yes

→ Other specifications

Degree of protection from front side	IP65 (DIN EN 60529); IP69K (ISO 20653)
Ambient temp. operating min.	-40 °C
Ambient temp. operating max.	+85 °C
Storage temperature min.	-40 °C
Storage temperature max.	+85 °C
Environmental resistance	acc. to IEC 60068-2-14, -30, -33 and -78
Salt spray	IEC 600 68-2-11
ROHS compliant	yes
REACH compliant	yes

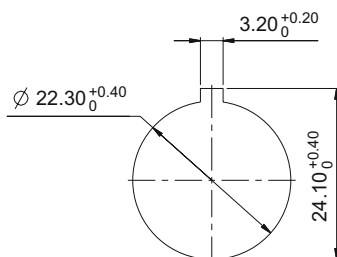
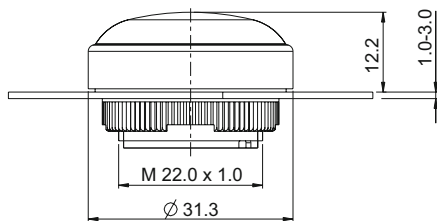

Panel cut-out to IEC 60947-5-1

Approvals



Accessories RAFIX 22 FSR - Signal indicators

→ Description	Photo	Order no.	Additional accessories see page
LED 3 mm		-	-
LED base for 3 mm THT LED, used in signal indicators, for RAFIX FS PCB		-	-
QC LED base for signal indicators		-	-
Fixing spanner for ring nut		5.05.800.062/0000	-

RAFIX 22 FSR Signal indicator

Technical data see page 14

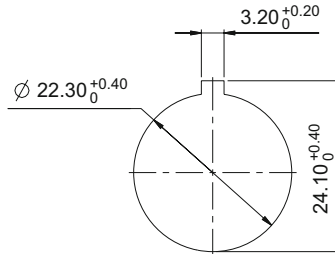
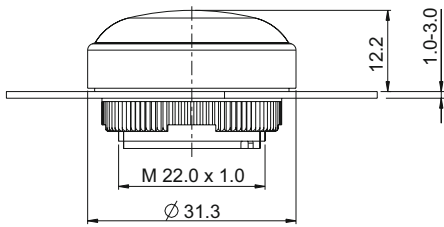

Panel cut-out to IEC 60947-5-1



→ Illuminability	Color of lens	Order no.
yes	translucent red	1.74.509.011/2300
yes	translucent yellow	1.74.509.011/2400
yes	translucent green	1.74.509.011/2500
yes	translucent blue	1.74.509.011/2600
yes	translucent white	1.74.509.011/2200



The information in this brochure only contains general descriptions and / or performance features, which may not apply precisely as described to the respective application, and which may change due to further product enhancements. The technical data, illustrations and other information about our products are the mere results of individual technical testing. These descriptions and other product features are only binding if they expressly agreed upon at the time of the

conclusion of a binding contract. In all other cases, we reserve the right to make technical changes as well as changes of availability. Pictures and other graphic illustrations are approximations only.

All product names may be trademarks or brand names of the RAFI Group or any other sub-supplier of RAFI. The use of such by any third parties for their own purposes may infringe the rights of the respective entity holding those rights.

RAFI GmbH & Co. KG

Ravensburger Str. 128–134, D-88276 Berg/Ravensburg
Tel.: +49 751 89-0, Fax: +49 751 89-1300
www.rafi.de, info@rafi.de

RAFI