



GET IN
TOUCH

WITH E-BOX

Universal and easy to use

E-BOX

THE COMPLETE HOUSING FOR RAFIX 22 FS⁺ CONTROL COMPONENTS



The elegant and flat E-BOX is used where individual control elements are required at remote locations – for example emergency stop applications along a production facility or at a safety fence.

The compact dimensions of the E-BOX match the edge dimension of a 40-mm profile rail. Even assembly is configured accordingly. It is designed to be uncomplicated and fast – thanks to the modular system of housing top and bottom, contact module with switching element, actuator or the alternative complete variation with its M12 connection.

For assembly videos, see www.rafi.de/e-box.



E-BOX INSTALLATION CONCEPT

- Insert the metal clip into the notch in the profile rail (the alignment nubs on the clip provide locking, then affix with only one screw)
- The metal clip can also be screwed onto other surfaces

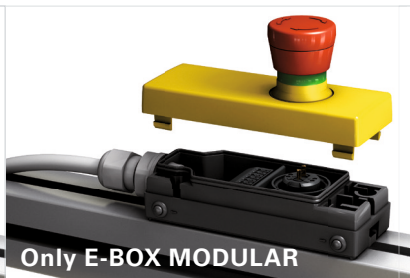

- Attach the bottom of the housing
- Insert the contact module
- Feed in the cable
- Contact the wire ends
- Insert RAFIX 22 FS⁺ actuator (for example emergency stop) in the top part of the housing
- Fix the actuator using the threaded ring
- Clip the housing top to the bottom – done
- Attach the housing to the metal clip and connect the cable using the M12 plug

Hole pattern for direct installation

As an alternative to the metal clip installation method, the bottom of the housing can also be directly attached using M4 screws.

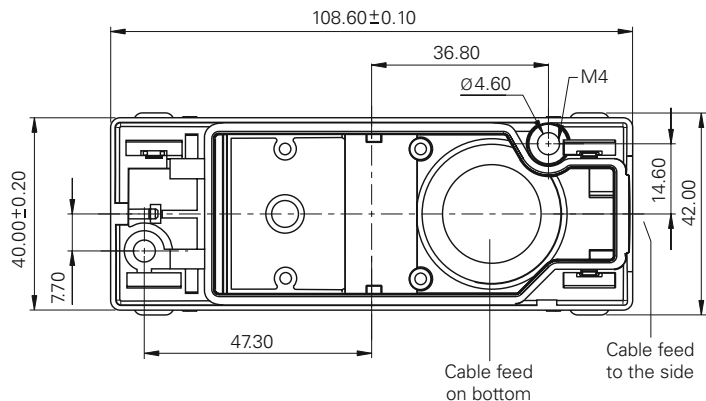

UNIVERSAL AND STABLE

PROFILE RAILS

Profile rails can be used everywhere for stable designs of all kinds, even over wide spans. As a result, they are used in many types of machines and systems: in logistics and production, in CNC machines and automatic injection moulding machines, in transport systems and conveying systems or in chassis design for robotic assembly systems. Even industrial work tables and testing tables are usually constructed using aluminium profiles. Some internationally marketed types of profiles are also suitable for use in building safety fences.

Different washers or woven screens can be used depending on the frame profile. The profile rail accessory program is generally very extensive and suitable for all types of applications.

The E-BOX installation concept is designed for compatibility with the profile rail. However, it can also be installed on cast iron, wood, plaster, concrete or other surfaces – using either the metal clip or direct installation using screws.



E-BOX MODULAR Housings

- • Extremely compact (dimensions 109 x 40 x 27 mm)
- Suitable for actuators from the RAFIX 22 FS⁺ control unit range (mounting hole \varnothing 22.3 mm)
- With yellow housing cap for emergency-stop actuators
- With grey housing cap for standard actuators, such as pushbuttons
- Fixing with the timesaving one-hole screw attachment method, particularly suitable for aluminium profile rails or alternatively by direct attachment with M4 screws
- Includes respective cable lead-in for direct cabling: side M16 or bottom: M20

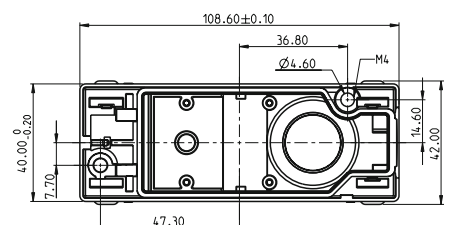
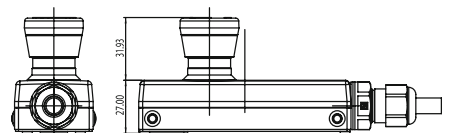
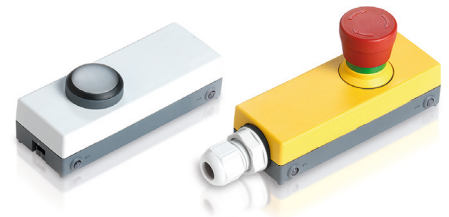

Technical Data

→ General information	
Color of housing cap	see order block
→ Dimensions	
Dimensions	109 x 40 x 27 mm
Mounting hole	22.3 mm
→ Mechanical design	
Cable attachment	see order block
→ Other specifications	
Protection as per EN 60529	IP65
Protection class	II
Temperature range	as per IEC 60947-5-1, depending on actuators used
ROHS compliant	yes
REACH compliant	yes

Approvals



UL in preparation

CONTROL COMPONENTS

E-BOX MODULAR

E-BOX MODULAR Housing yellow for emergency-stop pushbuttons



Cable attachment side

Technical data see page 3

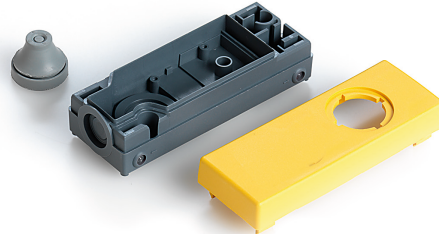

Cable attachment bottom

side M16	yellow	1.20.810.310/0000
bottom M20	yellow	1.20.810.311/0000

Accessoires:

E-BOX MODULAR - Contact modules for emergency-stop pushbuttons: see page 6.

Fitting RAFIX 22 FS⁺ emergency-stop pushbuttons see page 8, other variants see RAFI catalog "Electromechanical Components".

E-BOX MODULAR Housing grey for standard actuators



Cable attachment side

Technical data see page 3

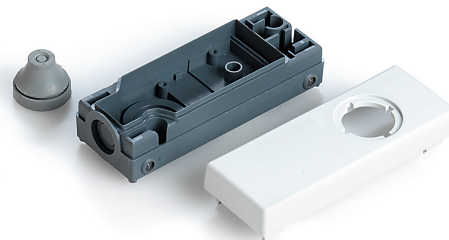

Cable attachment bottom

side M16	grey	1.20.810.308/0000
bottom M20	grey	1.20.810.309/0000

Accessoires:

E-BOX MODULAR - Contact modules for standard actuators: see page 7.

Fitting RAFIX 22 FS⁺ pushbuttons see page 8, other variants see RAFI catalog "Electromechanical Components".

E-BOX MODULAR Contact modules with gold contacts

- • With RAFIX 22 FS⁺ contact block for emergency-stop pushbuttons or standard actuators
- Contact block with 2 contact cavities (for emergency-stop pushbuttons "Plus 1" with 3 contacts)
- Option with LED for illuminated actuator components
- Line connection 0,2 .. 0,75 mm², rigid wire, wire with or without cable end sleeve

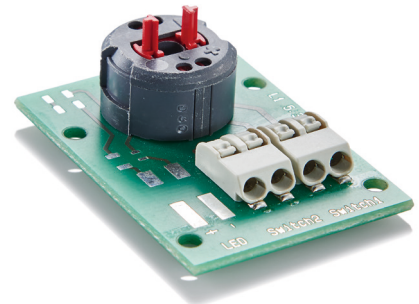

Contact module for emergency-stop pushbuttons

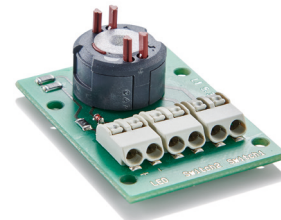

Contact module for standard actuators

Technical Data

→ General information

Lamp optional	LED
---------------	-----

→ Mechanical design

Contact system	bridge-contact
Contact materials	Au
Contact arrangement	see order block
NC contact forcibly actuated acc. to IEC 60947-5-1	yes
Robustness	100 N

→ Electrical characteristics

Operating voltage AC/DC min.	5 V
Operating voltage AC/DC max.	35 V
Operating current AC/DC min.	1 mA
Operating current AC/DC max.	100 mA
Rated power max.	250 mW

→ Other specifications

Operating life at 10 mA/24 V DC	see order block
Switching reliability at 24V/5mA DC	10×10^6
Ambient temp. operating max.	+70 °C
Ambient temp. operating min.	-25 °C
Storage temperature min.	-40 °C
Storage temperature max.	+80
Color of plunger	see order block
Robustness	acc. to IEC 60947-5-5 (TÜV)
Shock resistance acc. to IEC 60068-2-27	50 g at 11 ms, amplitude half sinusoidal
Resistance to vibrations acc. to IEC 60068-2-6	5 g at 10 ... 500 Hz
Environmental resistance	acc. to IEC 60068-2-14, -30, -33 and -78
Type	see order block
LED / color	see order block
ROHS compliant	yes
REACH compliant	yes

Approvals



UL in
preparation

E-BOX MODULAR Contact module for emergency-stop pushbuttons

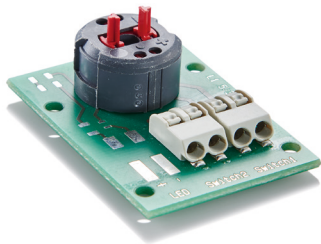

Technical data see page 5

Au	2 NC + 1 NO	Emergency stop „Plus 1“	-	50,000	red	5.00.100.226/0100
Au	2 NC	Emergency stop	-	1,000,000	red	5.00.100.221/0100
Au	2 NC	Emergency stop LED red		1,000,000	red	5.00.100.222/0100
Au	2 NC	Emergency stop LED green		1,000,000	red	5.00.100.225/0100
Au	2 NC	Emergency stop LED white		1,000,000	red	5.00.100.224/0100



RAFIX 22 FS⁺ Emergency-stop pushbutton, reset by rotation

Technical data see RAFI catalog "Electromechanical Components"

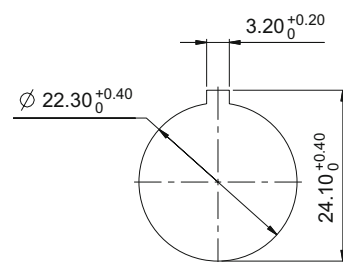
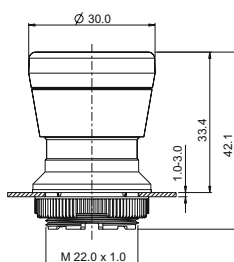

Panel cut-out to IEC 60947-5-1

by clockwise rotation	yes, lens translucent white	IP65 (DIN EN 60529)	1.30.273.011/2200
by clockwise rotation	yes, lens translucent red	IP65 (DIN EN 60529)	1.30.273.011/2300
by clockwise rotation	no	IP65 (DIN EN 60529)	1.30.273.511/0300

Only use with contact modules for emergency-stop pushbuttons.
Other variants see RAFI catalog "Electromechanical Components".

E-BOX MODULAR Contact module for standard actuators

Technical data see page 5

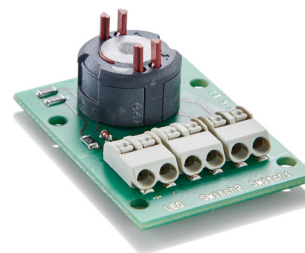

Au	1 NC + 1 NO	Universal	-	1,000,000	red and green	5.00.100.234/0100
Au	1 NC + 1 NO	Universal	LED yellow	1,000,000	red and green	5.00.100.236/0100
Au	1 NC + 1 NO	Universal	LED red	1,000,000	red and green	5.00.100.235/0100
Au	1 NC + 1 NO	Universal	LED green	1,000,000	red and green	5.00.100.237/0100
Au	1 NC + 1 NO	Universal	LED blue	1,000,000	red and green	5.00.100.238/0100
Au	1 NC + 1 NO	Universal	LED white	1,000,000	red and green	5.00.100.239/0100
Au	2 NO	Universal	-	1,000,000	green	5.00.100.240/0100
Au	2 NO	Universal	LED yellow	1,000,000	green	5.00.100.242/0100
Au	2 NO	Universal	LED red	1,000,000	green	5.00.100.241/0100
Au	2 NO	Universal	LED green	1,000,000	green	5.00.100.243/0100
Au	2 NO	Universal	LED blue	1,000,000	green	5.00.100.244/0100
Au	2 NO	Universal	LED white	1,000,000	green	5.00.100.245/0100
Au	2 NC	Universal	-	1,000,000	red	5.00.100.228/0100
Au	2 NC	Universal	LED yellow	1,000,000	red	5.00.100.230/0100
Au	2 NC	Universal	LED red	1,000,000	red	5.00.100.229/0100
Au	2 NC	Universal	LED green	1,000,000	red	5.00.100.231/0100
Au	2 NC	Universal	LED blue	1,000,000	red	5.00.100.232/0100
Au	2 NC	Universal	LED white	1,000,000	red	5.00.100.233/0100

CONTROL COMPONENTS

E-BOX MODULAR



RAFIX 22 FS⁺ Pushbutton, flush lens, round collar

Technical data see RAFI catalog "Electromechanical Components"

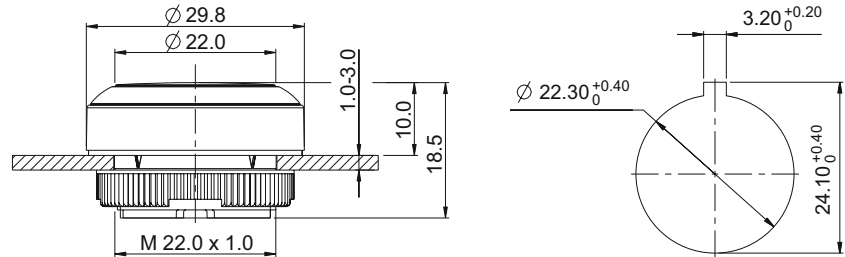

Panel cut-out to IEC 60947-5-1

yes	translucent red	1.30.270.001/23xx	1.30.270.021/2300	1.30.270.011/23xx	1.30.270.031/2300
yes	translucent yellow	1.30.270.001/24xx	1.30.270.021/2400	1.30.270.011/24xx	1.30.270.031/2400
yes	translucent green	1.30.270.001/25xx	1.30.270.021/2500	1.30.270.011/25xx	1.30.270.031/2500
yes	translucent blue	1.30.270.001/26xx	1.30.270.021/2600	1.30.270.011/26xx	1.30.270.031/2600
yes	translucent white	1.30.270.001/22xx	1.30.270.021/2200	1.30.270.011/22xx	1.30.270.031/2200
no	opaque slate-grey	1.30.270.001/07xx	1.30.270.021/0700	1.30.270.011/07xx	1.30.270.031/0700
no	opaque black	1.30.270.001/01xx	1.30.270.021/0100	1.30.270.011/01xx	1.30.270.031/0100

xx = Front ring color: black = 01, red = 03, yellow = 04, green = 05, blue = 06, slate grey = 07, silver grey = 08

Legending on request.

Other standard actuators see RAFI catalog "Electromechanical Components".

E-BOX M12

→ The **E-BOX M12** is a ready, fully equipped housing including actuators and indicators. Thus, e.g. emergency stop, on-off and up / down functions, also be realized with additional status displays with the very compact dimensions of the E-BOX.

Mounting: screw the clip, fit the box, plug in, check and finished.

The E-BOX M12 can be used anywhere that single command equipment units are required at remote locations. Typically, for example, for emergency stop applications along a production facility or on the hard guard. The dimensions of the E-BOX M12 are based on the edge dimension of a 40 mm mounting rail and the mounting concept is designed accordingly.



Technical Data

→ General information

Color of housing cap	see order block
----------------------	-----------------

→ Dimensions

Dimensions	123,2 mm x 40 mm, height depending on actuators used
------------	--

→ Mechanical design

Mounting	with clip in 40 mm aluminum rails
Connection	M12
Plug M12	see order block
Actuator 1	see order block
LED actuator 1	see order block
Actuator 2	see order block
LED actuator 2	see order block

→ Electrical characteristics

Operating voltage AC/DC min.	5 V
Operating voltage AC/DC max.	35 V
Operating current min.	1 mA
Operating current max.	100 mA
Rated power max.	250 mW

→ Other specifications

Protection as per EN 60529	IP65
Protection class	II
Operating temperature min.	-25 °C
Operating temperature max.	+70 °C
Operating life / B10	depending on actuators used
ROHS compliant	yes
REACH compliant	yes

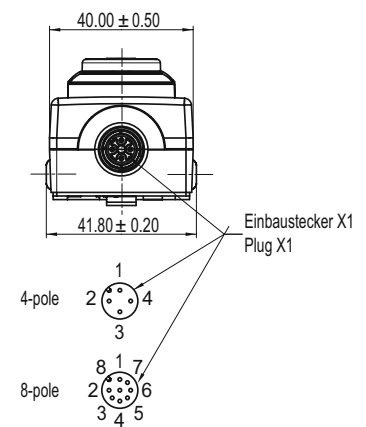

Approvals



UL in preparation

CONTROL COMPONENTS

E-BOX M12



E-BOX M12 Emergency-stop

Technical data see page 9

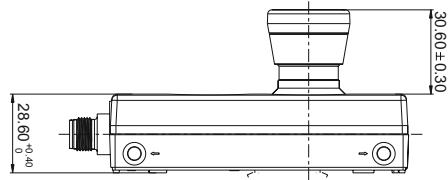

4-pin	E-Stop (2NC); 2NC: 1-2 / 3-4	-	-	-	1.22.114.000/0000
8-pin	E-Stop (2NC + 1NO); 2NC: 5-6, 7-8; 1NO: 3-4	-	-	-	1.22.176.000/0000



E-BOX M12 Emergency-stop with pushbutton

Technical data see page 9

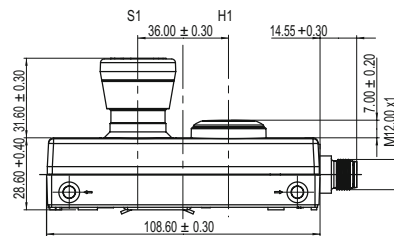

8-pin	E-Stop (2NC); 2NC: 3-4, 7-8	-	Pushbutton flat green (1NO); 1NO: 1-2	LED green; 5-6	1.22.114.212/0500
8-pin	E-Stop (2NC); 2NC: 3-4, 7-8	-	Pushbutton FLEXLAB flat white (1NO); 1NO: 1-2	LED white; 5-6	1.22.114.392/0200

E-BOX M12 1 pushbutton FLEXLAB

Technical data see page 9

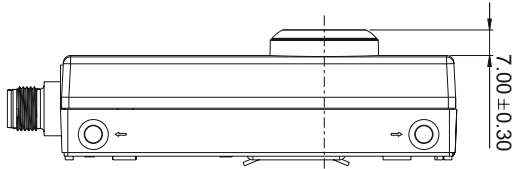

4-pin	Pushbutton FLEXLAB (1NO); 1NO: 3-4	LED white; 1-2	-	-	1.22.392.000/2000
-------	------------------------------------	----------------	---	---	-------------------

E-BOX M12 2 pushbuttons

Technical data see page 9

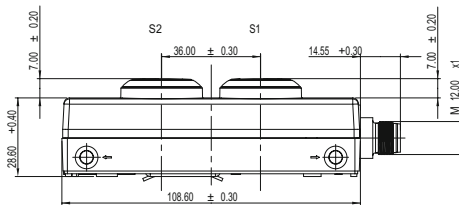

4-pin	Pushbutton flat white (1NO); symbol „arrow“; 1NO: 3-4	-	Pushbutton flat white (1NO); symbol „arrow“; 1NO: 1-2	-	1.22.242.242/0000
8-pin	Pushbutton FLEXLAB flat white (1NO); 1NO: 3-4	LED white; 7-8	Pushbutton FLEXLAB flat white (1NO); 1NO: 1-2	LED white; 5-6	1.22.392.392/2200

CONTROL COMPONENTS

E-BOX M12

05 / 2017



E-BOX M12 - 2 pushbuttons, flush/protruding lens

Technical data see page 9

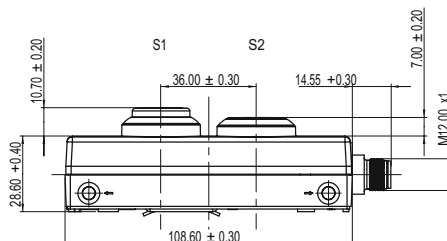

4-pin	Pushbutton protruding red, symbol "0" (1NC); 1NC: 3-4	-	Pushbutton flat green symbol "I" (1NO); 1NO: 1-2	-	1.22.251.242/3501
8-pin	Pushbutton protruding red, symbol "0" (1NC); 1NC: 3-4	LED red; 7-8	Pushbutton flat green symbol "I" (1NO); 1NO: 1-2	LED green; 5-6	1.22.251.242/3502



E-BOX Protective collar

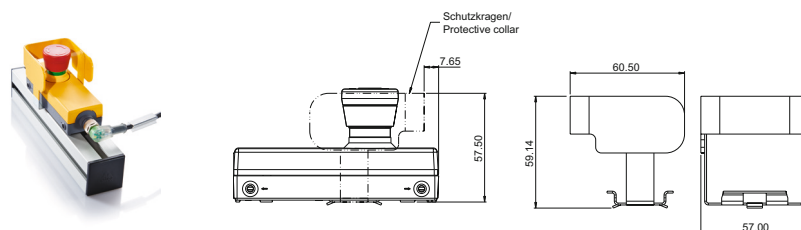

Protective collar for E-BOX MODULAR or E-BOX M12 with emergency stop

5.00.456.003/0000

To protect against accidental activation of the emergency stop.

The information in this brochure only contains general descriptions and / or performance features, which may not apply precisely as described to the respective application, and which may change due to further product enhancements.

The technical data, illustrations and other information about our products are the mere results of individual technical testing. These descriptions and other product features are only binding if they expressly agreed upon

at the time of the conclusion of a binding contract. In all other cases, we reserve the right to make technical changes as well as changes of availability. Pictures and other graphic illustrations are approximations only. All product names may be trademarks or brand names of the RAFI Group or any other sub-supplier of RAFI. The use of such by any third parties for their own purposes may infringe the rights of the respective entity holding those rights.

RAFI GmbH & Co. KG

Ravensburger Str. 128-134, D-88276 Berg/Ravensburg

+49 751 89-0, Fax: +49 751 89-1300

www.rafi.de, info@rafi.de

RAFI